

# Systematic Approach to Arowana Gender Identification Problem using Algorithm of Inventive Problem Solving (ARIZ)

The 9th TRIZ Symposium in Japan, 2013  
September 5-6, 2013

TriZit Benjaboonyazit  
Thai-Nichi Institute of Technology, Thailand

**Name** : TriZit Benjaboonyazit (pronounced Trai-Sit in Thai, means 3 successes)

**Education** : M.Eng (Electrical Engineering) , The University of Tokyo, Japan

**Present Work** : Faculty of Engineering, Thai-Nichi Institute of Technology, Thailand

**Experiences with TRIZ** : While working at Technology Promotion Association (Thailand-Japan), the author has learned TRIZ from Shinsuke Kurosawa Sensei of SANNO Institute of Management, Japan in 2005 after which he has founded the public TRIZ e-learning website titled TRIZThailand.Community, and has participated in the TPA Study Mission to Japan on Product and Process Innovation by TRIZ in 2006 and 2007. He is the author of many articles and books on TRIZ.



# Background of the problem

The author came across this problem of arowana gender identification when he visited a golden arowana farm in the southern part of Thailand and tried to look at this problem from the viewpoint of a TRIZ practitioner.



# Problem Situation

Arowana is a beautiful and expensive fish. Many farms try to improve their efficiency in breeding arowana, but the problem is that arowana is monomorphic which makes it difficult to distinguish male from female by their appearance. This causes difficulties in mating and selling of arowana. Many trial-and-error methods have been used with little success.



# Learning from success of similar cases

## TRIZ Black Boxes Problem

Similar monomorphic problems in other fields have been searched for to find out whether there were any inventive principles that could be applied, and luckily one was found in the problem of distinguishing two identical black boxes, each containing one of the two different electrical circuits.

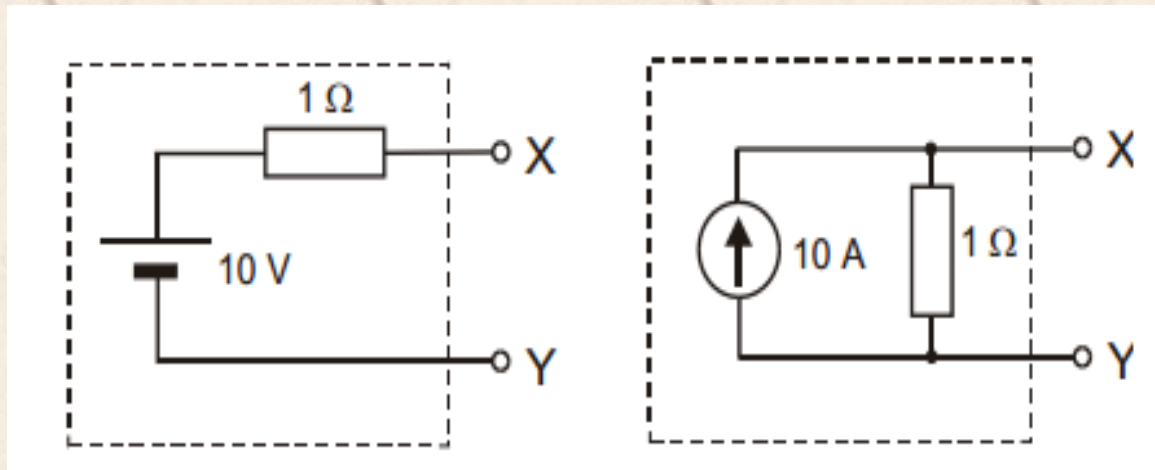

# Trapped in Psychological Inertia

Electrical engineers are likely to be trapped within their psychological inertia by using their expertise in circuit analysis without success since the two different electrical circuits in the black boxes are equivalent ones of the same circuit.

No matter what value of  $R$  is connected to the external terminal X-Y, The current (A) and voltage (V) at the terminal X-Y of both circuits will always be the same.

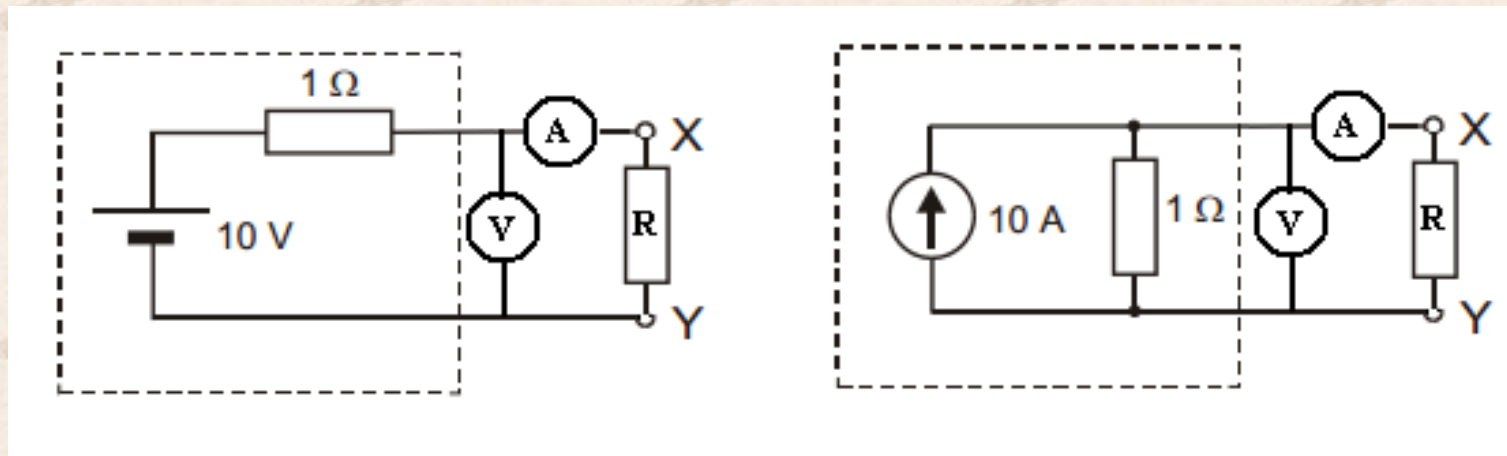

# TRIZ's concept of Resources

With nothing connected to the external terminal X-Y (open circuit), the difference of the 2 black boxes can be easily identified by detecting the thermal field and magnetic field emitted from inside the boxes.

The box with current flowing through conductor inside will generate heat and magnetic field around the conductor.

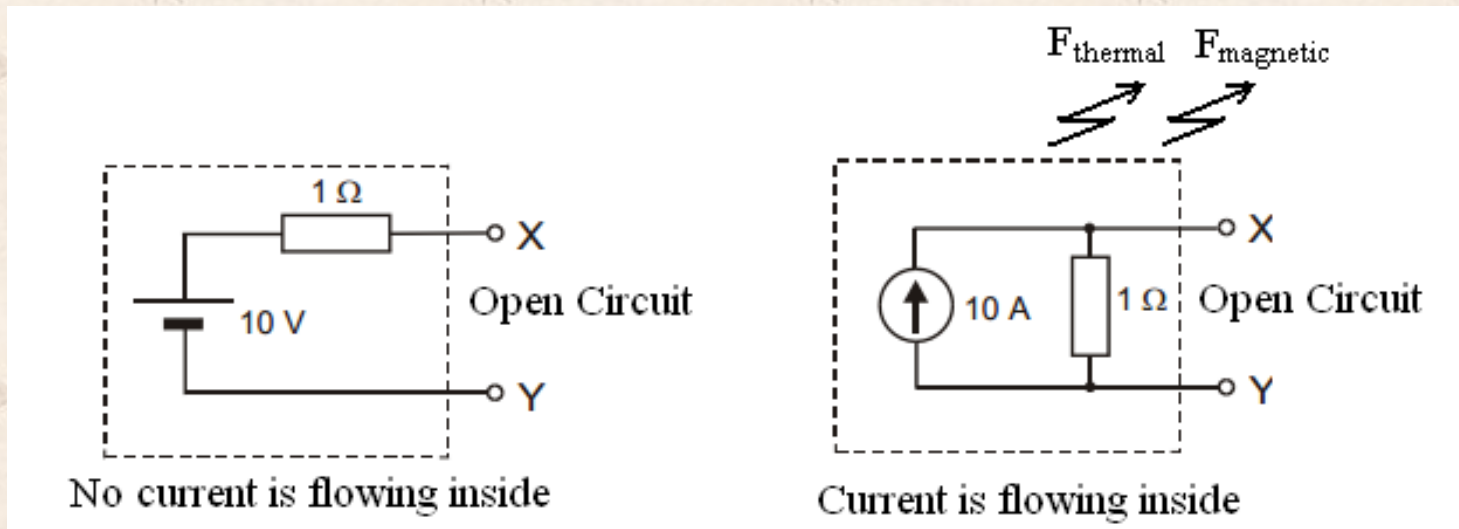

# Apply the black boxes solutions to Arowana Gender Identification Problem

Possible Solutions :

**Idea 1:** Detect difference in body temperature between them.

**Idea 2:** Detect and utilize magnetic field they might emit.



These ideas are not final solutions. They leave the clues as secondary problem for us to investigate the possibilities.

Are there any other resources and other possible solutions ?



# Challenging with ARIZ

Since TRIZ's concept of resources is one of the important parts in the Algorithm of Inventive Problem Solving (ARIZ), the author has challenged to use ARIZ to systematically analyze the problem and search for other possibilities to identify the gender of arowana.



# ARIZ-85C

Part 1. Analyzing the Problem

Part 2. Analyzing the Problem Model

Part 3. Formulating the Ideal Final Result  
and Physical Contradiction

Part 4. Mobilizing and Utilizing Substance-Field Resources

Part 5. Applying the Knowledge Base

Part 6. Changing or Substituting the Problem

Part 7. Analyzing the Method for Resolving  
the Physical Contradiction

Part 8. Capitalizing on the Solution Concept

Part 9. Analyzing the Problem-Solving Process

# Problem Description

Arowana is monomorphic which makes it difficult to distinguish male from female by their appearance. This causes difficulties in mating and selling of arowana. Many trial-and-error methods have been used with little success.

Arowanas reach their maturity around the 4th year. A female arowana has a single ovary which contains around 20 ~ 30 large ova. A mature male arowana possesses a single thread-like testis.

Attempts have been made to identify the gender of arowana by exposing their sexual organs, but this may endanger their lives.

# 1.1 Formulate the Mini-Problem

A bio-technological system for identifying the gender of arowana consists of male arowana, female arowana, a tank with freshwater, air bubbles, forage, exposing element and human eye.

Mini-problem : It is necessary, with minimum changes to the system, to identify their gender without harming their lives.



Technical Contradictions (TC) are formulated as follows,

◆ TC-1: If the arowana's sexual organs are exposed with strong exposing element, it is easy to identify their gender, but this may endanger their lives.

◆ TC-2: If the arowana's sexual organs are exposed with weak exposing element, their lives are safe, but it is difficult to identify their gender.

**Note:** In this wording, the author has changed the specialized term *knife or cutter* to the general term *exposing element* to avoid psychological inertia.

## 1.2 Define the Conflicting Elements

- ◆ Workpieces: arowana's sexual organs
- ◆ Tool: exposing element and human eye



# 1.3 Build Graphical Models for the Technical Contradictions

## TC-1: with strong exposing element

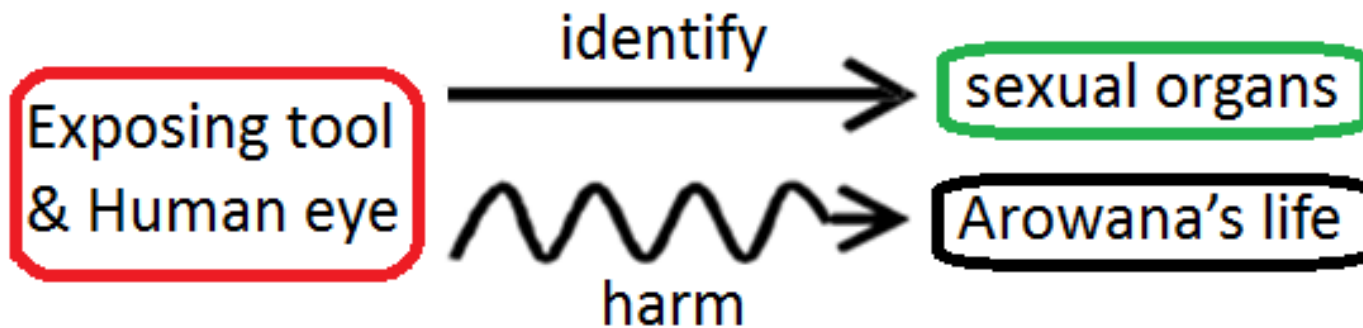

## TC-2: with weak exposing element

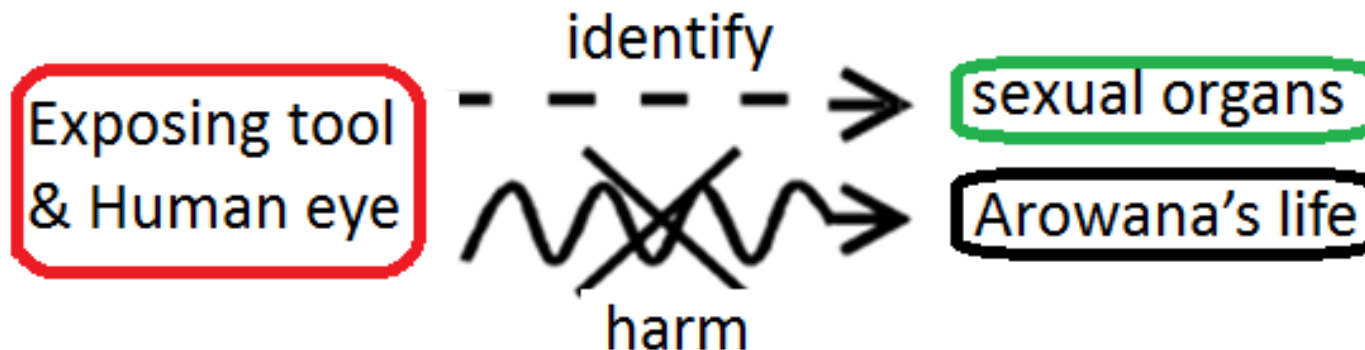

## 1.4 Select a Graphical Model for Further Analysis

In the problem of identifying the gender of arowana, the main useful function is identifying the gender of arowana. Thus, we choose TC-1: in this case the arowana's sexual organs are exposed with strong exposing element.

At this state, we might try to solve the problem of eliminating harmful effect by thinking of Standard solution 1.2.2 (modifying the tool) or Inventive principle #21 (Rushing through)

**Idea 3:** Use something like laser surgery technique which is strong, fast and precise.

**Remark:** This seems possible, but the cost is high and the safety of the fish cannot be guaranteed.



## 1.4 Select a Graphical Model for Further Analysis (continued)

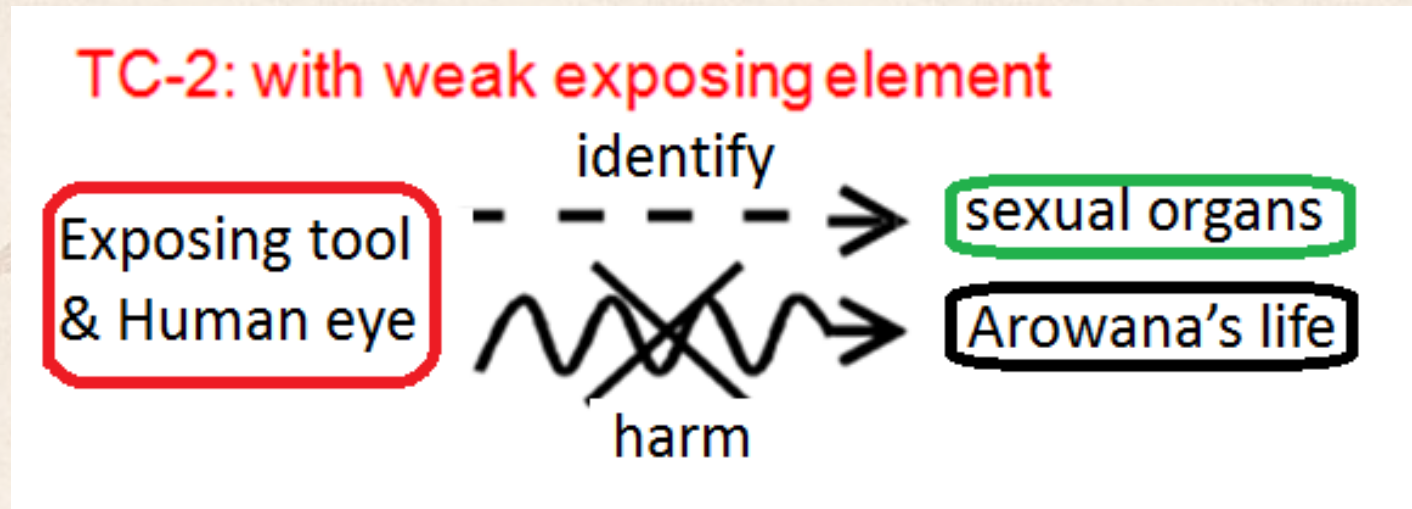

Although, in this problem, the main useful function is identifying the gender of arowana, since the safety for arowana is given first priority, we choose TC-2: in this case the arowana's sexual organs are exposed with weak exposing element, and then, we try to solve the problem of improving the useful function.

## 1.5 Intensify the Conflict

### TC-2: with absent exposing element

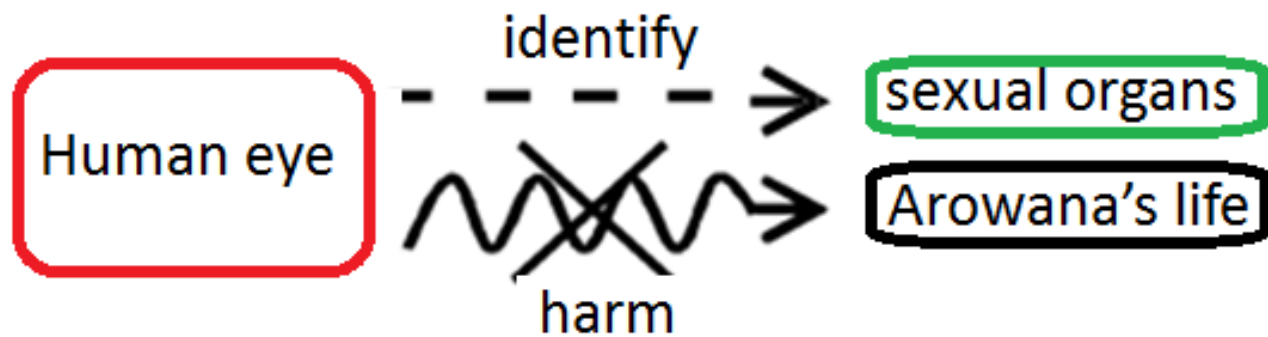

In order not to compromise (trade off) the useful function with the harmful effect, we intensify the conflict by considering that instead of “weak exposing element”, it is replaced by “absent exposing element” in TC-2.

# 1.6 Formulate the Problem Model

TC-2: with absent exposing element

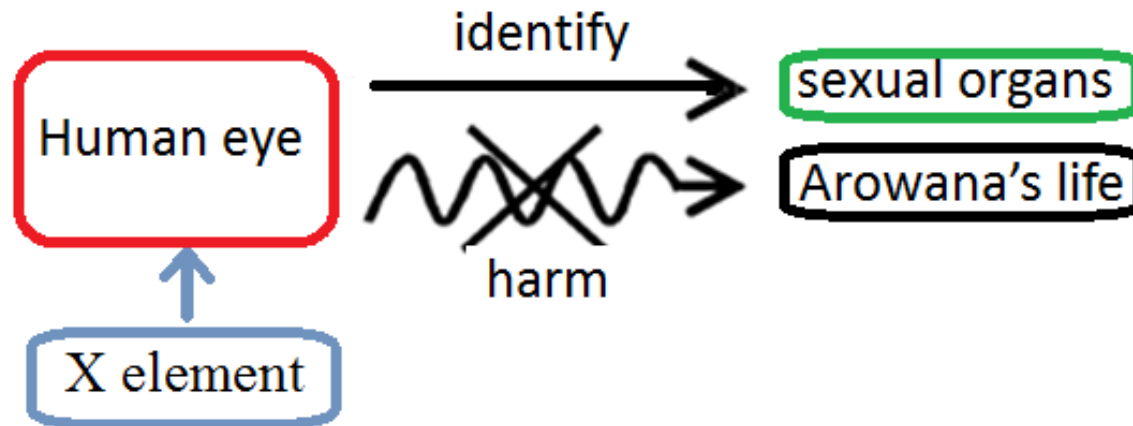

Find an X element that maintains the feature of the absent exposing element (i.e., does not harm arowana) while providing an easy way to identify the gender of arowana.

# 1.7 Apply the System of Standard Solutions

Since this is a problem of detection, we try to apply a standard in class 4 (4.2.1. change the field without interfering with the original system).

**Idea 4:** Use ultrasound.

A = human eye

B = arowana's sexual organs

C = arowana's life

F1 = light

F2 = ultrasound

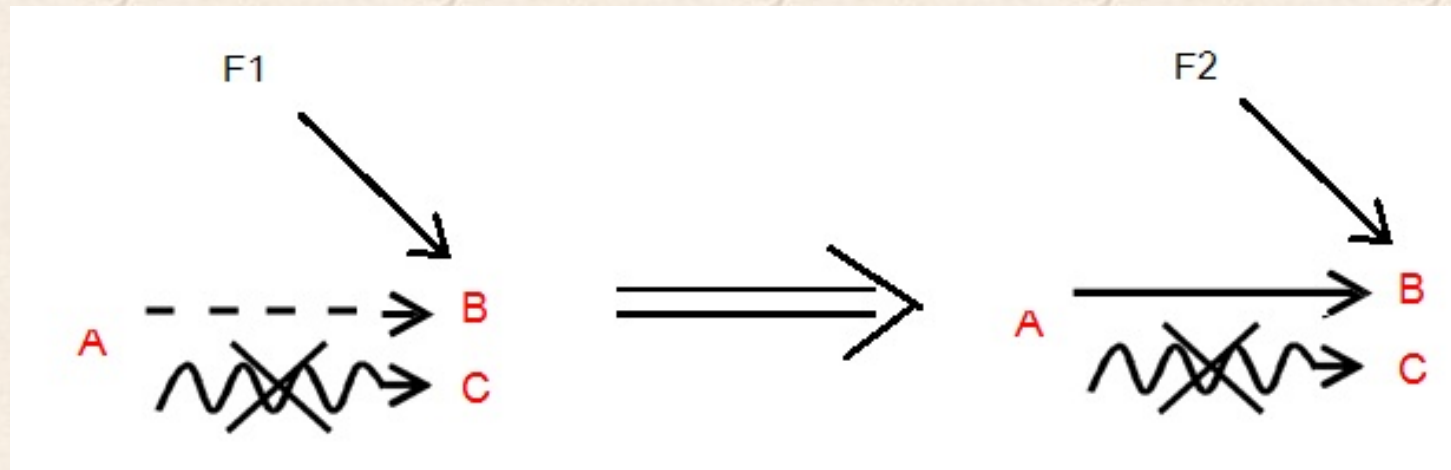

# 1.7 Apply the System of Standard Solutions (continued)

Since the human eye cannot see the sexual organs directly, an ultrasound image monitor (D) must be added.

This seems to be a good solution, but in actual application, the system fails due to the thick scale (E) of arowana.

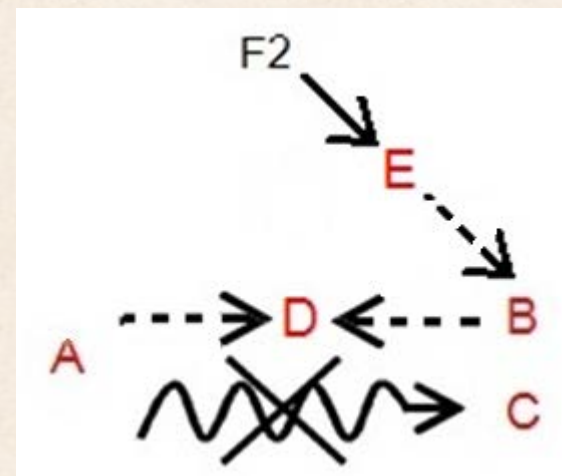
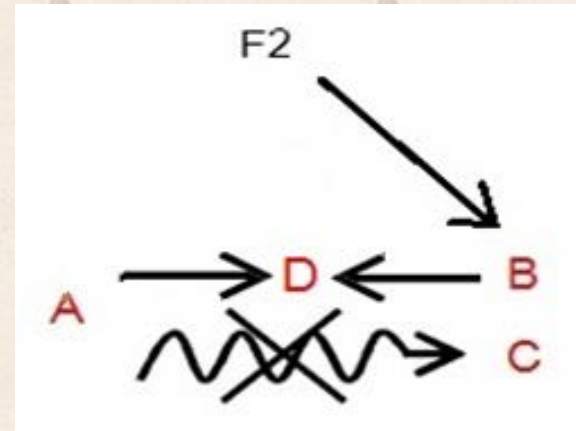

## 2.1 Define the Operational Zone (OZ)

In the problem of identifying the gender of arowana, the Operational Zone is defined to be the place around the sexual organs of arowana.

## 2.2 Define the Operational Time (OT)

In the problem of identifying the gender of arowana, the Operational Time is defined to be the period of time during which arowana's sexual organs are observed.

## 2.3 Define the Substance and Field Resources

In the problem of identifying the gender of arowana, the absent exposing element is considered, and thus substance field resources (SFR) include only substances and fields in the analyzed system and the environment. In this case, besides the tank, freshwater, air bubbles, forage, and the fish itself, we can **consider any substance or energy emitted from or absorbed by the fish body as SFR.**

**Idea 5-12:** At this state, we create a list of substance field resources and try to generate ideas from these resources as in the following table.



## 2.3 Define the Substance and Field Resources (continued)

### List of SFR and ideas generated

Substance Field Resources	S or F	Ideas generated
Secretion	S	Used for sex hormone testing.
Weight	F	Male arowana is likely to be heavier.
Body temperature	F	Female arowana is likely to have higher body temperature.
Reflection of light	F	Scales of male and female arowana reflect different color of light.
Acoustic sound	F	Male and female arowana emits different sound.
Odour	S	Female arowana emits smell to attract male arowana.
Male arowana	S	Used as detector to detect smell from female arowana.

## 3.1 Identify the Formula for IFR-1

The Ideal Final Result by introducing the X element is defined as follows,

The X element does not complicate the system at all, does not create any harmful effects, improves the function of “identifying the gender of arowana” of exposing element during the observation period, while maintaining the ability of the tool “not to harm arowana’s life.”

## 3.2 Intensify the Formula for IFR-1

We intensify the formula of IFR-1 by introducing an additional requirement that the X element comes from substance field resources.

The X element does not complicate the system at all, does not create any harmful effects, improves the function of “identifying the gender of arowana” of exposing element during the observation period, while maintaining the ability of the tool “not to harm arowana’s life”, and the X element should be substituted by “substance field resources (SFR)”

### 3.3 Formulate the Physical Contradiction for the Macro-Level

Sexual organs (operational zone) should be exposed during observation period (operational time) to identify the gender of arowana, and should not be exposed after observation is finished, to protect their lives.

At this state, no idea is generated, so we go on to the next step.

## 3.4 Formulate the Physical Contradiction for the Micro-Level

Particular atoms should be there around sexual organs (operational zone) during observation period (operational time) to identify the gender of arowana, and should not be there after observation is finished, to protect their lives.

At this state, we try to formulate the new Ideal Final Result as in the next step.

## 3.5 Formulate the Ideal Final Result (IFR-2)

The ordinary atoms around the sexual organs (operational zone) should, on their own, be transformed into particular atoms during observation period (operational time) to identify the gender of arowana. After observation is finished, the particular atoms should, on their own, be transformed into ordinary atoms.

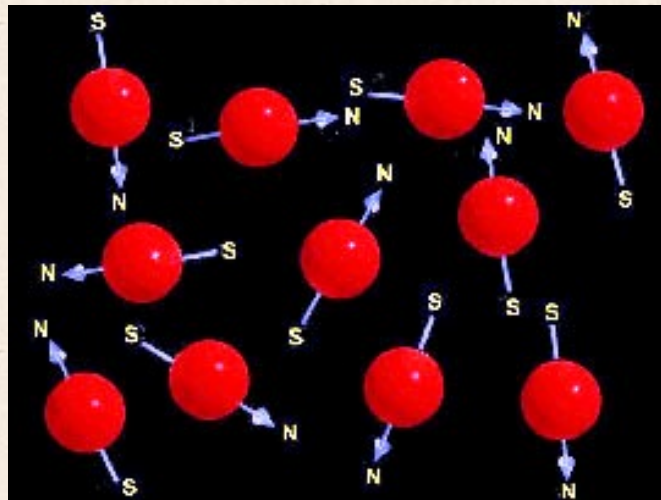

## 3.6 Consider Solving the New Problem Using the System of Standard Solutions

Standard 2.4.7. Use natural phenomena (such as alignment of objects with the field, or loss of ferromagnetism above the Curie point.)

Standard 4.4.5. Measure the effects of natural phenomena associated with magnetism, etc.

**Idea 13:** Use Magnetic Resonance Imaging (MRI) to align the atoms around sexual organs and detect the resonance of particular nuclei.

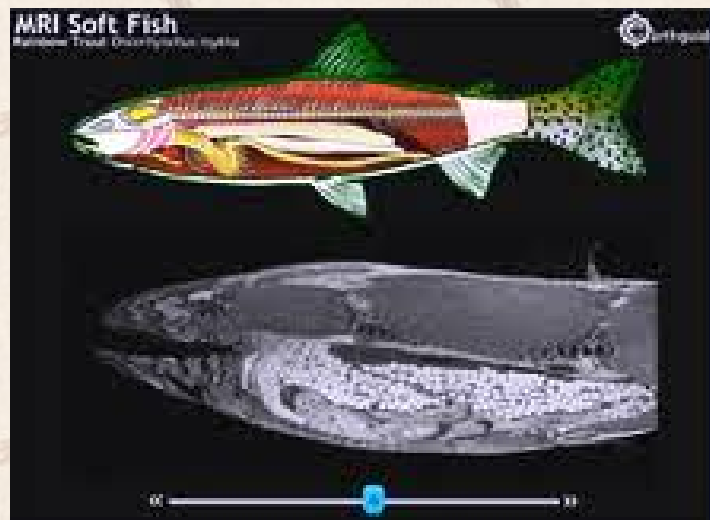

Earthguide & Scripps Institution of Oceanography

# 4.1 Simulation with Smart Little People

Smart Little People (SLP) of skin use both hands tied together and do not expose arowana's sexual organs.

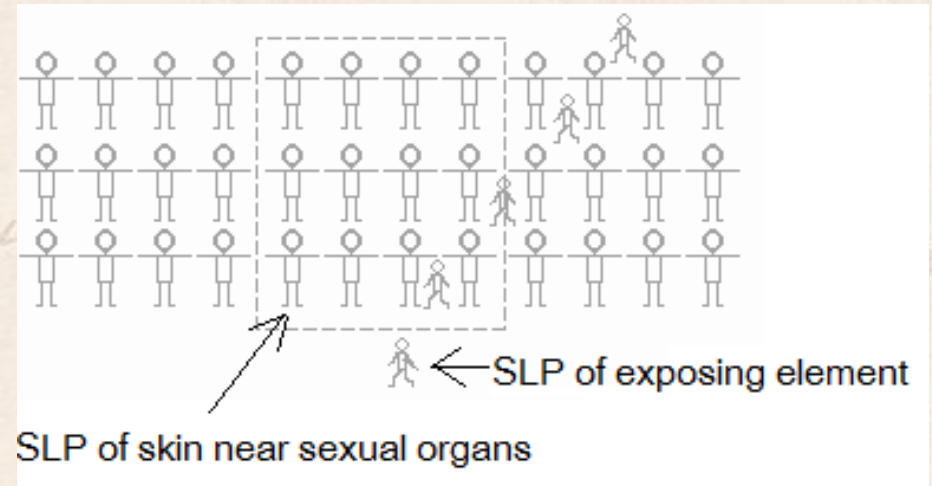

Smart Little People (SLP) of skin drop their hands, thus make it easy to expose arowana's sexual organ.

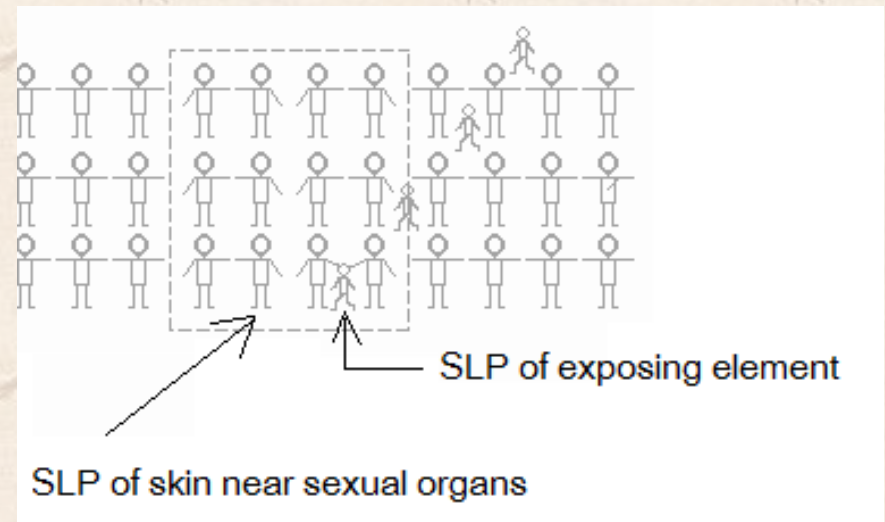



# 4.1 Simulation with Smart Little People (continued)

## **Problem:**

How to find a way to make the smart little people of skin near the opening to sexual organs release their gripped hands

## **Idea 14:**

Use lubrication oil substance and send spy to sneak inside the opening. (a small ultrasound probe will be inserted through the opening to detect the image of sexual organs)

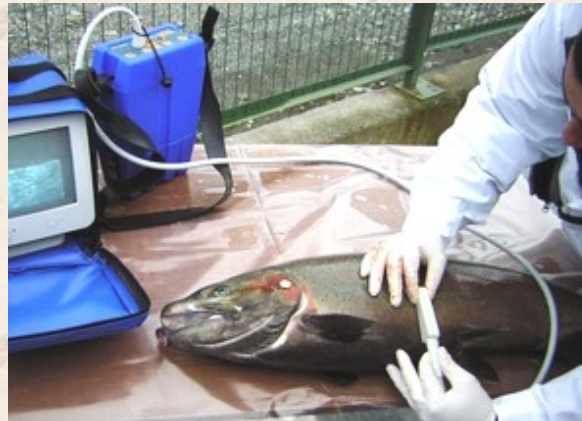

BCF Ultrasound

## 4.2 “Stepping Back” from the IFR

Note 39. ... However, it is not always the case that a problem can be solved with a small expenditure of resources. Sometimes we must step back and consider introducing “foreign” substances and fields. This should be done only when absolutely necessary — that is, if available SFR cannot be applied.

In this case, instead of using only Substance Field Resources inside the analyzed system and the environment, external resource is introduced into the system to work with internal resources in identifying the gender of arowana.

## 4.3 Using a Mixture of Substance Resources

Use mixture of substance resources discharged from arowana

**Idea 15:** Use secretion and excretion discharged from arowana for DNA testing

**Remark:** This is what is really done, but due to the high cost of DNA testing, it is not popular. Besides, there are still questions about its effectiveness due to the complexity in the chromosome of arowana.

## 4.4 Using Empty Space

**Idea 16:** Male arowana use their mouth to incubate the fertilized eggs until they become fry. So it is believed that male arowana have bigger mouth than female arowana. The size or volume of empty space in their mouth can be used to distinguish male from female arowana.

**Remark:** This method is widely used, but still it lacks accuracy and is considered unreliable.



## 4.5 Using Derived Resources

Consider solving the problem using derived substance resources or a mixture of derived substance resources with empty space.

**Idea 17:** Feed arowana in the tank with forage which contains some substance that intensifies color difference between male and female. In this case, color is the derived optical field.

**Idea 18:** Insert sensor inside the rectum to analyze stool excretion of arowana.

## 4.6 Using an Electrical Field

**Idea 19:** Male and female arowana might react differently under electric field.

**Idea 20:** Male and female arowana might emit some extent of electric field like that of an electric eel.

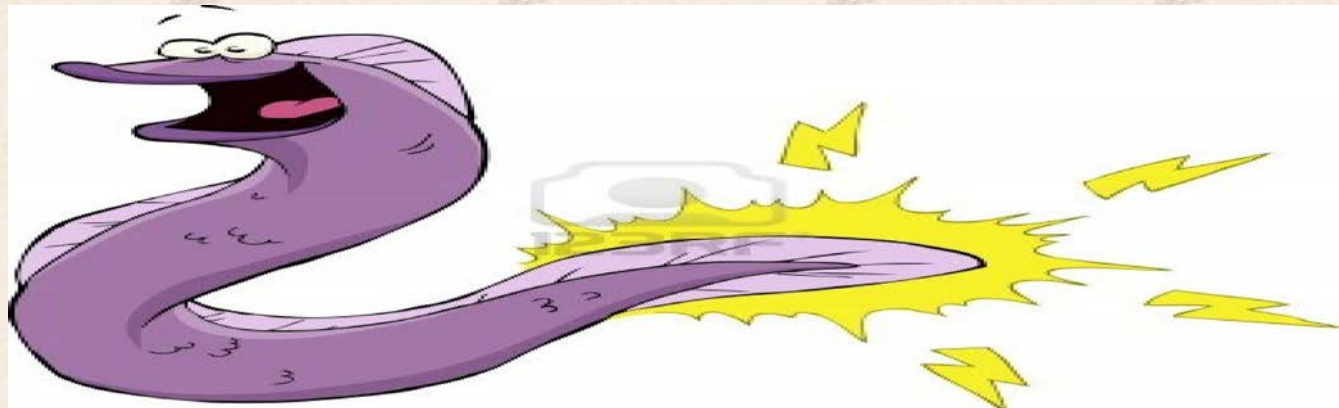

## 4.7 Using a Field and Field-Sensitive Substance

Recently microchips are inserted into the body of arowana to distinguish each individual fish.

**Idea 21:** Microchip with built-in temperature sensor can be inserted into the body of the fish to monitor the temperature difference between male and female arowana.



## 5.1 Consider solving the physical problem by applying the System of Standard Solutions

Standard 4.1.1 Instead of detecting or measuring, modify the system so that there is no longer a need for measurement.

**Idea 22:** Instead of trying to increase the productivity of arowana breeding by gender identification, change the breeding system to cloning system.

**Remark:** This seems to be a good idea, but cloned arowana are not preferred, besides, it goes beyond the limit of minimum changes to the system which is the condition initially defined by the mini-problem.



## 5.2 Consider solving the problem by applying solution concepts to problems that have already been solved

Problem with similar physical contradiction has been found in Sturgeons which have no external markers for sexing, and endoscopic observations of the sexual organs of sturgeons has been used to identify gender of this fish.

**Idea 23:** Use endoscopy technique to look inside the body to identify the gender of arowana.

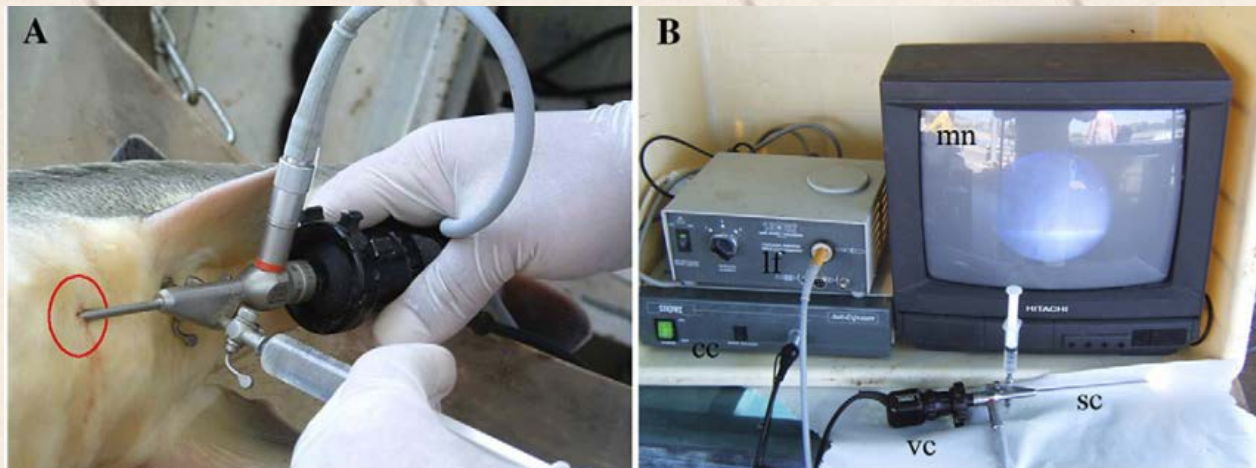

Department of Animal Sciences, The Hebrew University of Jerusalem

## 5.3 Consider resolving the Physical Contradiction by utilizing the Separation Principles

Physical Contradiction in step 3.3: Sexual organs should be exposed during observation period to identify the gender of arowana, and should not be exposed after observation is finished, to protect their lives.

Use Separation Principle in time

**Idea 24:** Use CT Scan during the observation period.

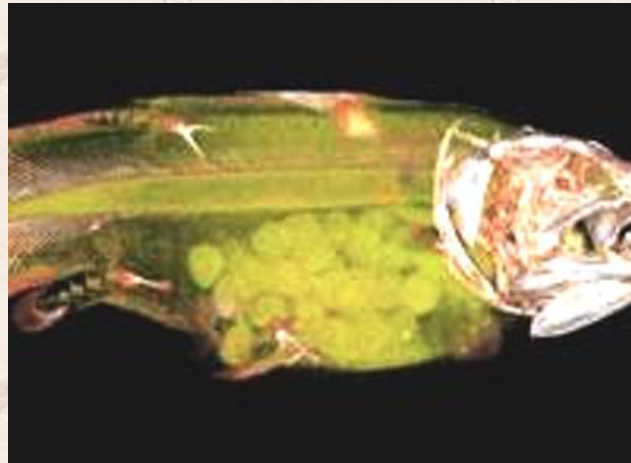

Bioscience and Biotechnology, Tokyo Institute of Technology

## 5.4 Consider resolving the Physical Contradiction by utilizing the library of natural effects and phenomena

**Idea 25:** Use X-Ray effect to penetrate through the scale of arowana to expose the sexual organs.

**Remark:** This seems practical, but the safety of the fish cannot be guaranteed.

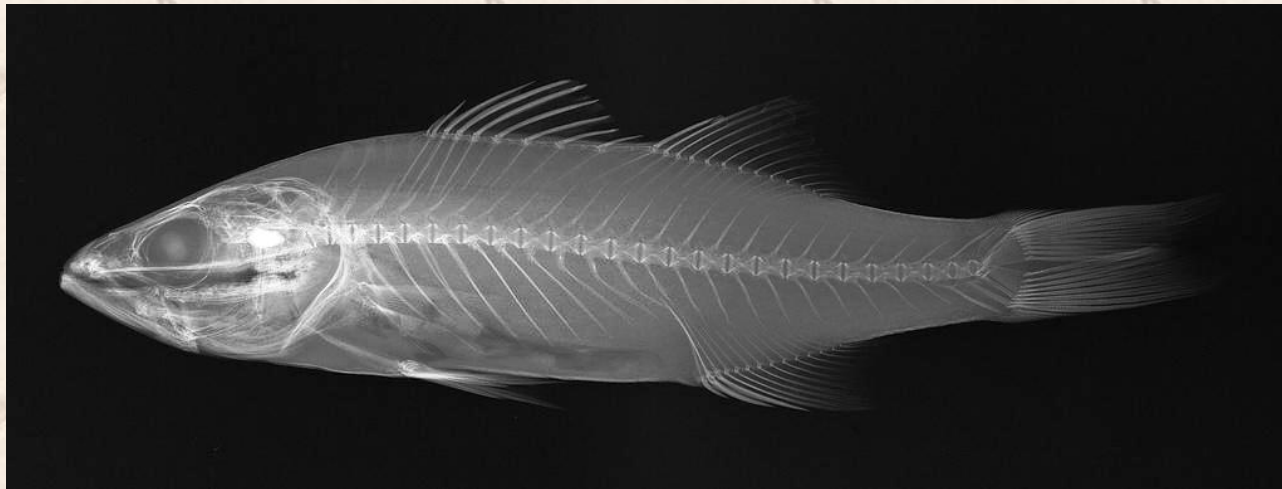

X-Ray Fish Photo from the Smithsonian Institute

# Part 6. Changing or Substituting the Problem

6.1 If the problem is solved, transfer the theoretical solution concept into a practical one.

6.2 If the problem is not solved, check to see whether the description in Step 1.1 represents a combination of several problems.

6.3 If the problem is still not solved, change the problem by selecting another Technical Contradiction in Step 1.4

6.4 If the problem is still not solved, return to Step 1.1 and reformulate the Mini-Problem with respect to the super-system.

## 6.3. Change the problem by selecting another Technical Contradiction in Step 1.4.

Ideas of Exposing tools generated in Part 3, Part 4 and Part 5 (Ultrasound, MRI, Endoscope or CT Scan) can be good solutions, but since they are expensive resources introduced into the system from outside, they are not ideal solutions. In order to move closer to the ideal final result, we change the problem by selecting another Technical Contradiction as below, and try to eliminate the harmful function.

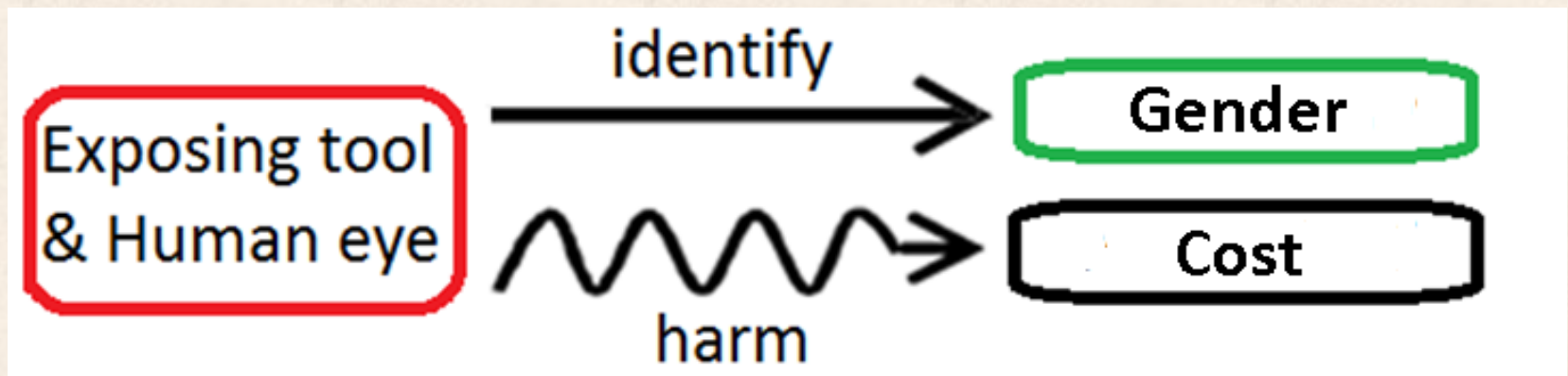

## 5.1 Consider solving the physical problem by applying the System of Standard Solutions (again)

Standard 1.2.2 Eliminating harmful interaction by introducing modified S1 and/or S2

**Idea 26:** The problem might be able to be solved by introducing a third substance which is available or derived substance field resources (SFR) to replace the existing substances (exposing tool).

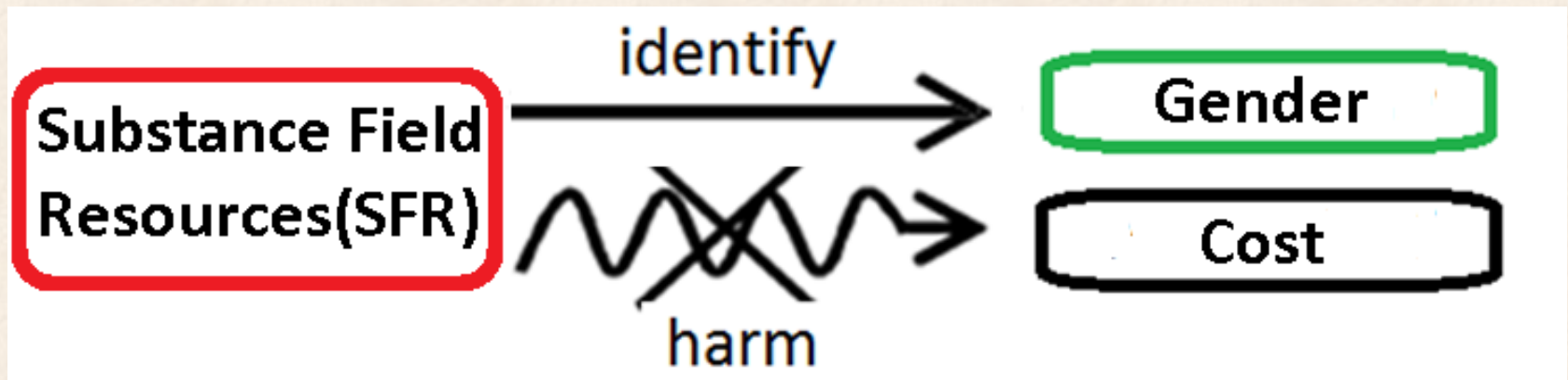

5.2 Consider solving the problem by applying solution concepts to problems that have already been solved (again)

Problem with similar physical contradiction has been found in other fishes (Tuna, Arapaima) using plasma vitellogenin derived from blood to distinguish male from female fish.

**Idea 27:** Use plasma vitellogenin derived from blood to identify the gender of arowana.

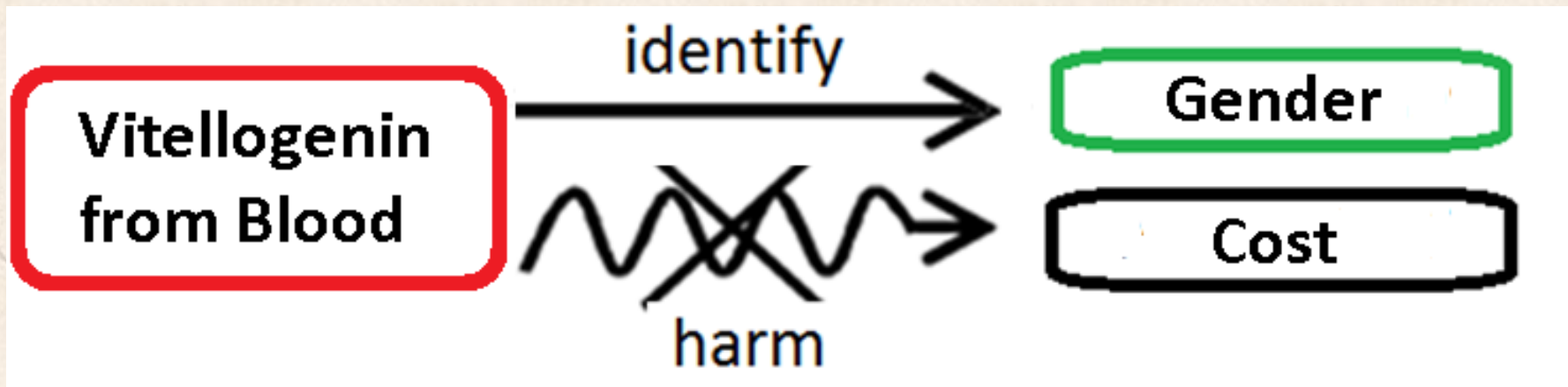

# Part 7: Analyzing the Method for Resolving the Physical Contradiction

## 7.1 Check the Concept of Solution.

*It is possible to apply available or derived SFR instead of introducing the substance/field from outside the system.*

*Vitellogenin can be considered as self-controlling substances. It is high in female and low in male arowana.*

## 7.2 Preliminary estimate of the solution concept.

*The solution concept meet the main requirement of IFR-1.*

*Physical Contradiction (in 6.3) is resolved by the solution concept.*

*The new system contains at least one easily-controlled element. Vitellogenin is self-controlled.*

*The solution concept found for a “single-cycle” Problem Model fits the real-life, “multi-cycle” situation.*



# Part 7: Analyzing the Method for Resolving the Physical Contradiction (Continued)

7.3 Check the novelty of the solution concept via a patent search.

*There is no patent on arowana gender identification using plasma vitellogenin yet.*

7.4 What sub-problems might appear during development of the new technological system?

*The sub-problems of analyzing plasma vitellogenin system to identify arowana gender for mating and selling will have to be solved.*

# Part 8. Capitalizing on the Solution Concept

8.1 Plasma vitellogenin analyzing system should be improved.

8.2 The changed system or super-system can be applied to other ornamental fishes.

8.3 Apply the solution concept for solving other problems:

- Formulate a general Solution Principle

Gender identification in monomorphic animal using plasma vitellogenin

- Consider direct application of the Solution Principle to other problems

**Idea 28:** Gender identification in monomorphic birds.

- Consider applying the opposite Principle to other problems

**Idea 29:** Use plasma vitellogenin to increase female arowana.

## Part 8. Capitalizing on the Solution Concept (Continued)

- Create a morphological matrix that includes all possible modifications of the solution concept, and consider every combination produced by the matrix. For example, “placing the parts” versus “applied fields” etc.

**Idea 30:** Combine fish body and thermal field by using Infrared Camera to detect fish body temperature pattern.

**Idea 31:** Combine fish body and optical field by using Night Vision Camera to detect the light pattern emitted from the body of fish at night.

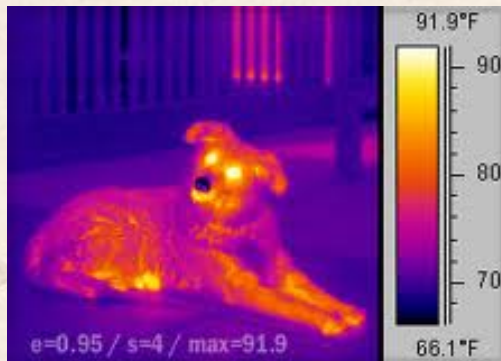

## Part 8. Capitalizing on the Solution Concept (Continued)

- Consider the modifications to the Solution Principle that would result from changing the dimensions of the system or its main parts, imagining the result if the dimensions were to approach zero or stretch toward infinity.

**Idea 32:** Use electron microscope to look into the chromosome inside the cell of arowana.

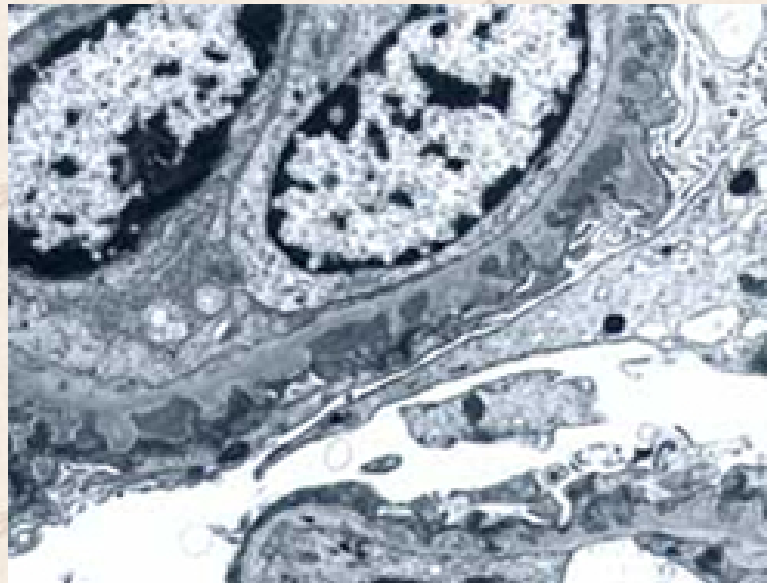

# Part 9. Analyzing the Problem-Solving Process

9.1 Compare the real process of problem solving with the theoretical one (that is, according to ARIZ). Write down all, if any, deviations.

Step 5.2 Apply the solution concepts to non-standard problems that have already been solved using ARIZ.

In this case, the solution concepts of problem with similar physical contradiction have **not** used ARIZ.

# Part 9. Analyzing the Problem-Solving Process (Continued)

9.2 Compare the solution concept you found to the information in the TRIZ knowledge base (Standard Solutions, Separation Principles, effects and phenomena libraries, etc.). If the knowledge base does not include a principle that applies to your solution concept, document this principle so that it can be considered for inclusion when revisions to ARIZ are made.

Standard 1.2.2. Eliminating harmful interaction by Introducing modified S1 and/or S2

At step 5.1, **new** substance from available and derived SFR (S3) is used to **replace** exposing tools to eliminate harmful interaction.

# Concluding Remark

The high potential solutions for Arowana gender identification problem are attained systematically by using Algorithm of Inventive Problem Solving (ARIZ).

More than 30 ideas are generated along the process of using ARIZ step by step from Part 1 to Part 9. The solution concepts develop gradually and become clearer and better when we come closer to the ideal final result. And finally, some high potential solutions such as using plasma vitellogenin from blood of arowana are proposed.

The solutions are not only useful for real world application, but the process to reach the solutions will also be useful for those who are interested in TRIZ and want to learn how to apply ARIZ to solve their problems.

The author hopes that this work will contribute to the progress and further development of TRIZ in an appropriate way.

# Acknowledgement

Finally, the author would like to express his grateful thanks to Shinsuke Kurosawa Sensei, who has endlessly devoted to the promotion of TRIZ and has guided the author to challenge using ARIZ in this work with his great advices.



# References

1. ARIZ-85C, <http://www.trizstudy.com>
2. Tools of Classical TRIZ, <http://www.ideationtriz.com/publication.asp>
3. Breeding Technique of Malaysian Golden Arowana, [http://www.aquarticles.com/articles/breeding/Suleiman Breeding Asian Arowana.html](http://www.aquarticles.com/articles/breeding/Suleiman_Breeding_Asian_Arowana.html)
4. Su-Field: An Educational Example of Inventive Problem Solving in Electrical Engineering, <http://www.triz-journal.com/archives/2006/01/05.pdf>
5. The use of ultrasound in the aquaculture industry, [http://www.bcfultrasound.com/ultrasound products/applications/fish](http://www.bcfultrasound.com/ultrasound_products/applications/fish)
6. Use of endoscopy for gender and ovarian stage determinations in Russian sturgeon, [http://departments.agri.huji.ac.il/animal/staff/faculty\\_staff/sivan\\_berta/publications/19-Hurvitz-et-al-2007-aquaculture.pdf](http://departments.agri.huji.ac.il/animal/staff/faculty_staff/sivan_berta/publications/19-Hurvitz-et-al-2007-aquaculture.pdf)
7. X-Ray Fish Photos from the Smithsonian Institute, <http://www.sites.si.edu/exhibitions/exhibits/ichthyo/>
8. First CT scan made of eggs inside coelacanth, [http://www.evolution.bio.titech.ac.jp/index\\_e.html](http://www.evolution.bio.titech.ac.jp/index_e.html)
9. MRI fish, Earthguide & Scripps Institution of Oceanography, <http://earthguide.ucsd.edu/fishes/technology/technology.html>
10. Gender determination in the Arapaimagigas using plasma vitellogenin, <http://www.riiaamazonia.org/PUBS/T18.pdf>

Thank you for your attention

[TriZit@gmail.com](mailto:TriZit@gmail.com)

<http://www.trizthailand.com>